

Meaning Making:  
Military



Peter Pang  
3D Design & Craft  
2016-2017

# Content

Personal Statement	2
Visits	3
Case Study in Order of Ranks	4
Pick a Colour	11
The Word Exercise	13
The Fashion Way of Design	15
Drawing & Sketches	23
The Fashion way of Making	27
Meaning Making	30
Work In Progress	34
Final Outcome	39
Other Products	47
Building a Brand	58
Appendix	59



# Personal Statement

Members of the British Armed Forces has been engaged in numerous operations, humanitarian missions and overseas deployments. It has been rated as the Top Ten most stressful jobs in the UK in 2017. Many servicemen have since suffered from injury, Post-traumatic Stress Disorder or even death. However, there should be more support and appreciation from the public.

My project is to start a brand with products designed and influenced by the unique cultures, customs and traditions of the military. The “RAF trench coat” will be the flagship product of the brand, more products will be released and on sale to the public. The brand also aimed for celebrating the hard work of our servicemen and gather more supports for the military personnel, to achieve that, a portion of the product sales will be donated to the respective Armed Force Associations to help the servicemen or their family in needs.

# Visits

## London

The Guards Museum  
Household Cavalry Museum  
RAF Museum  
Horse Guards Parade  
Sculptures around London



## Portsmouth

HMS Victory  
HMS Warrior  
Royal Marines Museum



## Hong Kong

Hong Kong Coastal Defence Museum



# Case Study in Order of Ranks

Meeting People

## Wing Commander Chan

Royal Hong Kong Auxiliary Air Force  
Government Flying Service

Formerly a Wing Commander in the Royal Hong Kong Auxiliary Air Force. After 1997 he remained in the Government Flying Service continue his service in Hong Kong as an Air Traffic Controller. It has been brought to me that many of the traditions and customs of the Royal Air Force have been lost when the RHKAAF has been renamed to GFS in Hong Kong. As more and more servicemen retired and quit the Air Force, they are finding difficulties passing on their cultures and customs.



# Major Francis

Royal Corps of Signals, British Army

As an officer of the British Army, he also works a 9-5 job in the civilian street. He currently locates at Brighton working for the Southampton University Officer Cadet Corps. His primary role is to get officer materials from the University to enrol as an officer in the British Army. He enjoys talking with different students and helps them to find a role which their learnt profession could help contribute the British Armed Forces.





## Lieutenant Dunn

Royal Hong Kong Regiment (V) British  
Army

A famous Hong Kong actor who also served in the British Army before the handover of Hong Kong from Britain to China. He spent the majority of his service securing the border between Hong Kong and Mainland China. He is most proud of being the last generation of “Chinese British Servicemen”. He recalled that getting a commission to be an officer is still regarded as the turning point and the most successful day of his life. It was Sandhurst, the officer school that turns him to a true gentleman.



## Second Lieutenant Shimmings

3 Battalion,  
The Princess of Wales's Royal Regiment

A university student at the University of Brighton. Joined the Southampton University Officer Cadet Training Corps. After a year of training with the corps, he applied what's known as "Zero to Hero" 4 weeks reserve Officer Training and became a 2nd Lieutenant in the Princess of Wales's Royal Regiment as a platoon commander in charge of 24 soldiers. However, he felt that the regiment has many bad customs as it was an amalgamation of older regiments. Most of the customs from the older regiments has been lost when the amalgamation took place. He is currently looking for different ways to record and pass on what is left of the P.W.R.R. Cultures and Customs.



# Warrant Officer Brian

RAF Regiment



A highly decorated soldier from the Royal Air Force. Spending more than 20 years in the Queens Colour Squadron.

He had guarded the Buckingham Palace, deployed to Iraq and Afghanistan multiple times. The high point of his life is when he was appointed as the Garrison Sergeant Major in Operation Herrick in Helmand Province, Afghanistan. Taking care of Officers and soldiers across the NATO International Forces. The most difficult part of the job is to write letters to the next of kin when servicemen are wounded or killed in action. He is also the overall in-charge of the celebration of RAF 100th Anniversary in April 2018.

# Flight Sergeant Moss

RAF Regiment



A close friend of WO Brian, a fellow serviceman in the Queens Colour Squadron in the Royal Air Force. He introduces me to the burning piano tradition of the Air Force which started from the RAF and gradually spread to the rest of the Air Forces in the world. Part of the reason why this tradition has spread to the world is because being the oldest Air Force in the world, they deploy to different countries training their fellow airmen across the world. With that, they bring along their proud traditions to other Air Forces. However, this kind of customs has largely remained unknown in the civilian world. It would be an honour for the airmen if people from the civilian street also appreciate and understand the tradition as well as they do.



# Sub-mariners

Royal Navy

Being a sailor is the most difficult job the Armed Force could offer. Most of the sailors have regular deployments on a ship for 9 months before returning home. Being a submariner is a larger challenge as they will be inside a submarine for the same period of time. They work inside a small space for 9 months. These group of submariners had recently finished their 9 months deployment in a submarine and granted a two-weeks leave starting from bonfire night. As a fellow countryman, a handshake and a photo to show respect would mean a lot for our servicemen. Even they are in uniform, they are still filled with emotion and knowing that I will be doing something for them is a major motivation for me to dedicate my time to the project.



# Pick a Colour



Guards Division



Royal Regiment of Scotland



Princess of Wales's Royal Regiment



Duke of Lancaster's Regiment



Royal Regiment of Fusiliers



1 Royal Anglian Regiment



2 Royal Anglian Regiment



3 Royal Anglian Regiment



Yorkshire Regiment



Mercian Regiment



Royal Welsh



Royal Irish Regiment



Parachute Regiment



Royal Gurkha Rifles



The Rifles



The Queen's Dragoon Guards



Royal Scots Dragoon Guards



Royal Dragoon Guards



Royal Yeomanry

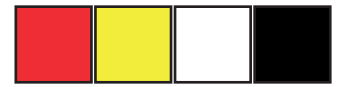

Royal Lancers



King's Royal Hussars



Light Dragoon



Royal Tank Regiment



Royal Yeomanry



Royal Wessex Yeomanry



Scottish and North Irish Yeomanry



Queen's Own Yeomanry



Army Air Corps



Adjutant General's Corps



Royal Military Police



Royal Regiment of Artillery



Royal Corps of Signals



Corps of Royal Engineers



Corps of Royal Electrical & Mechanical Engineers



Royal Logistic Corps



Intelligence Corps



Royal Army Medical Corps



Royal Army Veterinary Corps



Royal Army Dental Corps



Queen Alexandra's Royal Army Nursing Corps



Royal Army Physical Training Corps



Royal Air Force

# Pantone Accurate

#d7eaf9

#921a20

#061633

#323639

#3b4880

#68717a

#421416

#151b31

#d2b38b

#556b2f

#ffffff

#000000

# The Word Exercise

High Table  
Support  
Understand  
Respect  
Customs  
Regimental Pride  
Authenticity  
Traditions  
Gentleman  
Ceremonial  
Vintage  
Awareness  
POSH  
Service  
Hero  
Help  
Integrity  
Lest we forget  
Celebrate  
Excellence  
Honour



## Choose the correct font & typeface

The quick brown fox jumps over the lazy dog

**Baskerville SemiBold**

The quick brown fox jumps over the lazy dog  
**Minion Pro Bold Cond**

The quick brown fox jumps over the lazy dog  
Helvetica Light

The quick brown fox jumps over the lazy dog  
Academy Engraved S

The quick brown fox jumps over the lazy dog  
American Typewriter Regular

The quick brown fox jumps over the lazy dog  
Big Caslon Medium

The quick brown fox jumps over the lazy dog  
Embossed Germanica Regular

The quick brown fox jumps over the lazy dog  
Cambria Bold

**“The quick brown fox jumps over the lazy dog”  
is an English pangram used by many graphic  
designers and typographers to test their  
fonts and typeface. This pangram has all 26  
alphabets allowing designers to analyse every  
letter in one phrase.**

# The Fashion Way of Design

## Step 1: Get Influenced



Fig.1

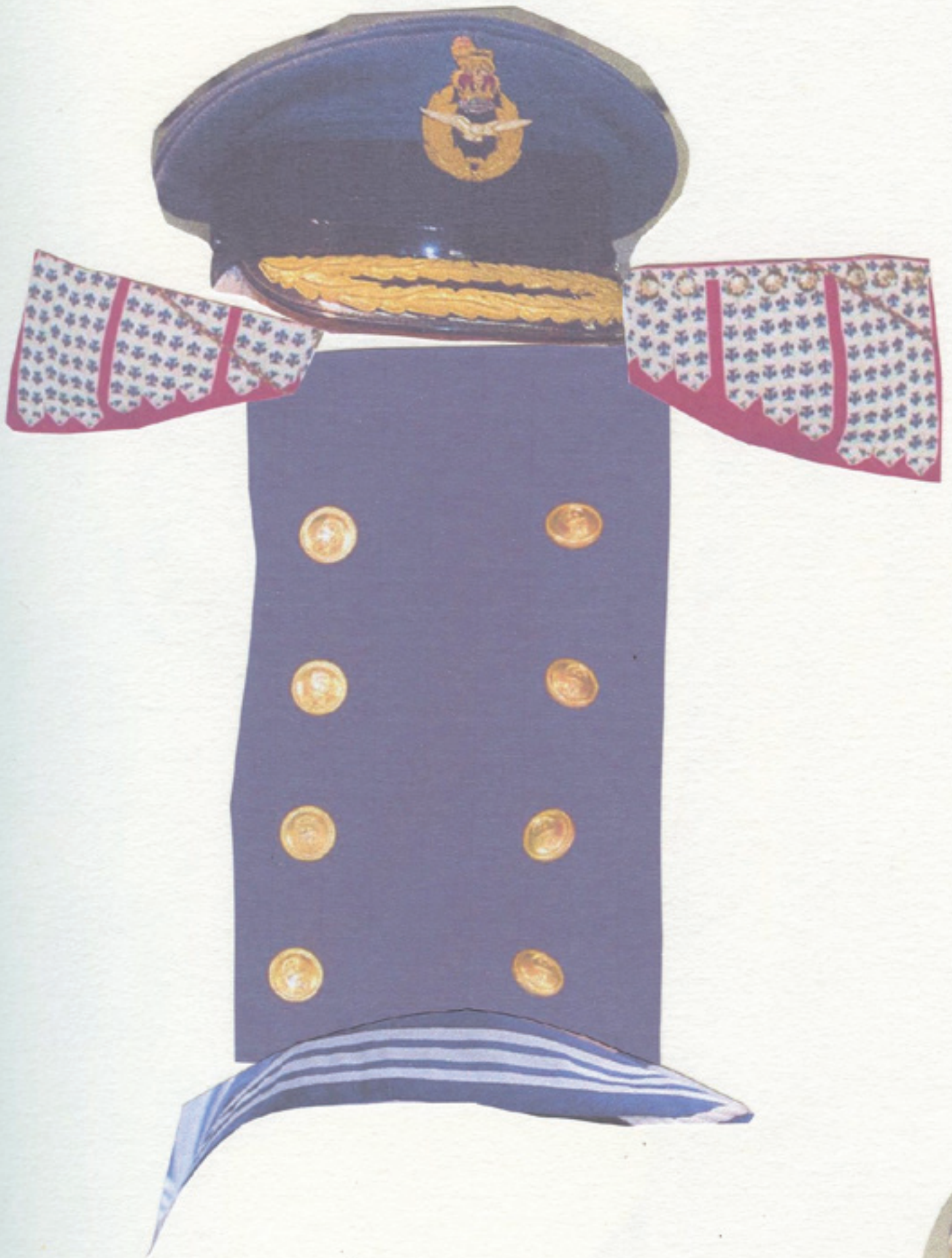

Fig.2



Fig.3

Step 2: Play Around with ideas





















### Step 3: Drawing



### Step 4: Material Samples





# Drawing & Sketches

Getting the feel and the forms right by drawing out different scenarios.















# The Fashion way of Making

## Step 1: Technical Flat

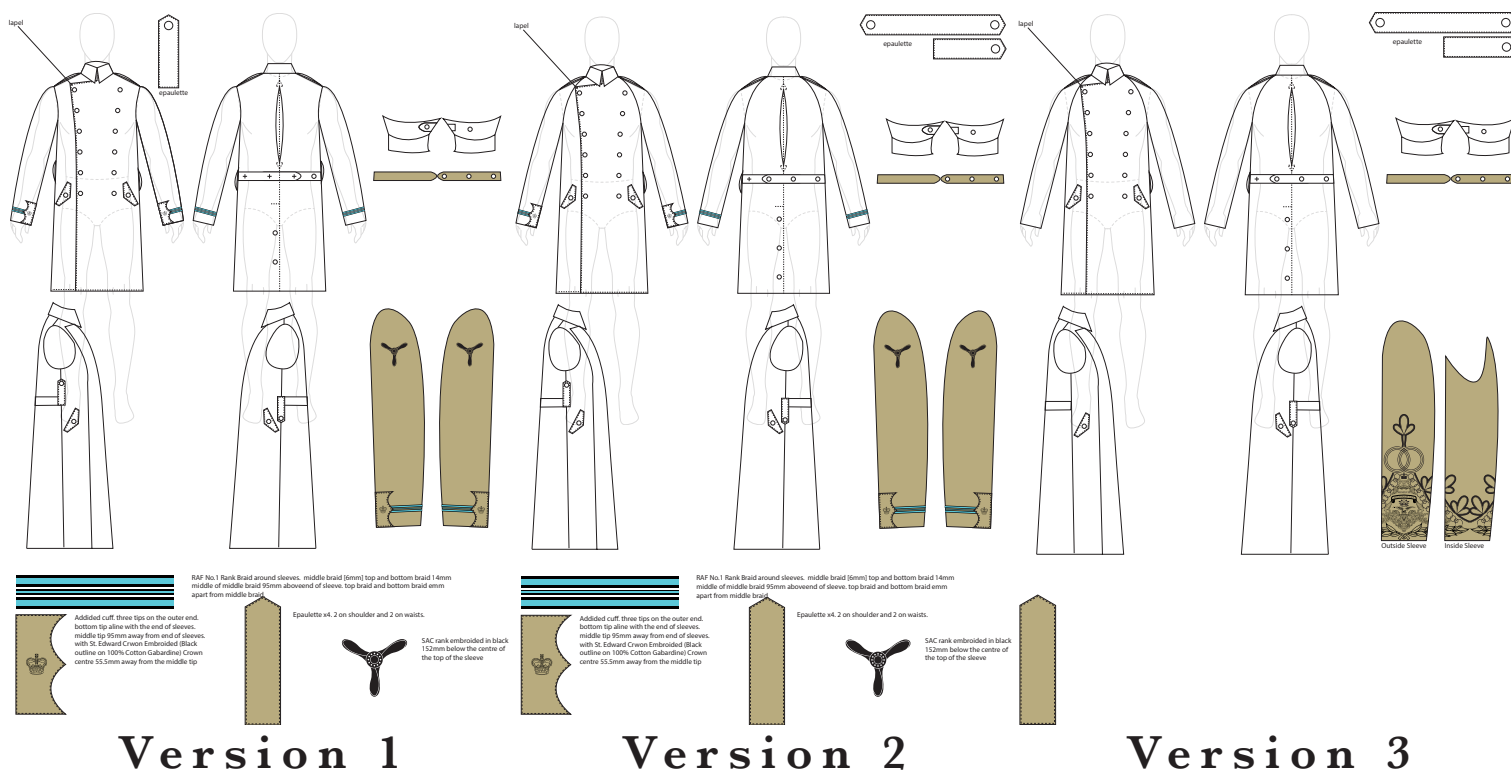

## Step 2: Paper pattern

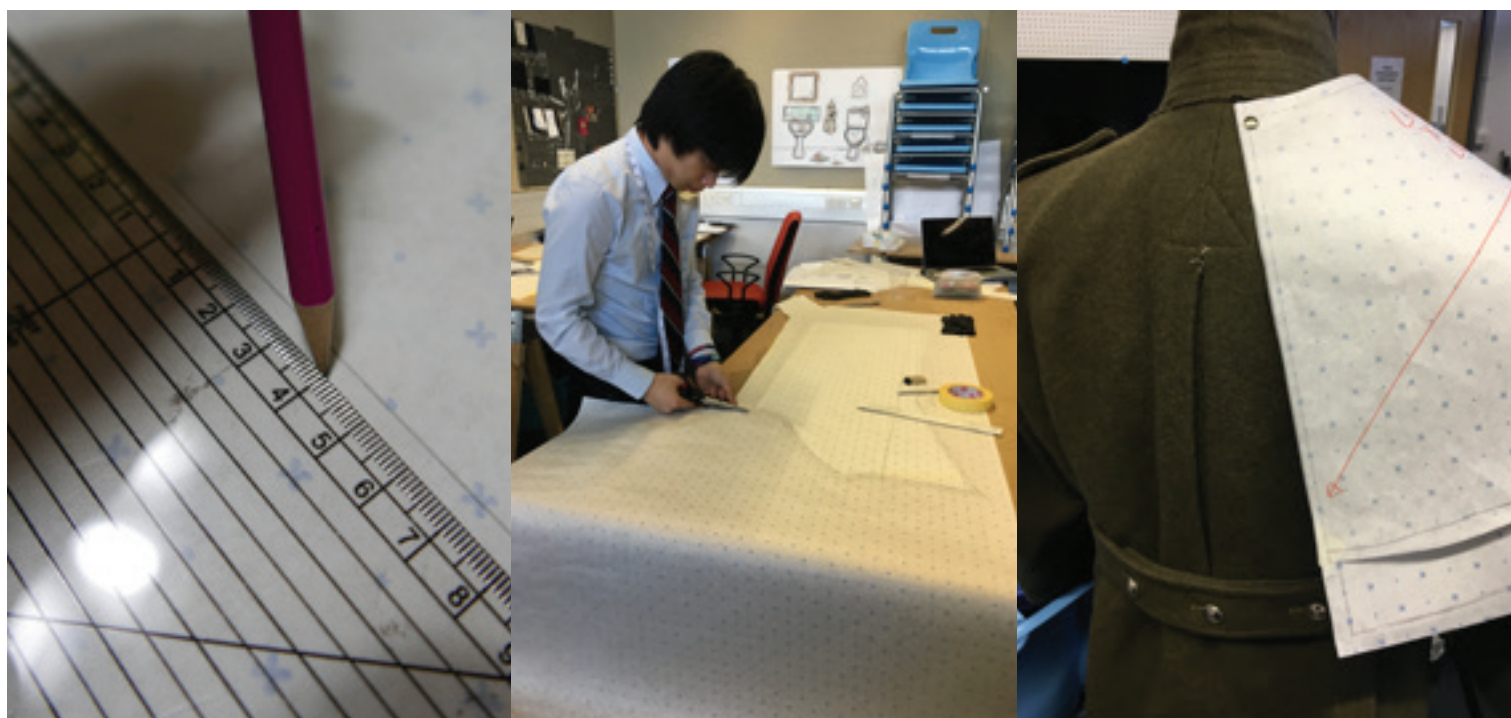

**Draw**

**Cut**

**Form Fitting**



### Step 3: Cut Fabric

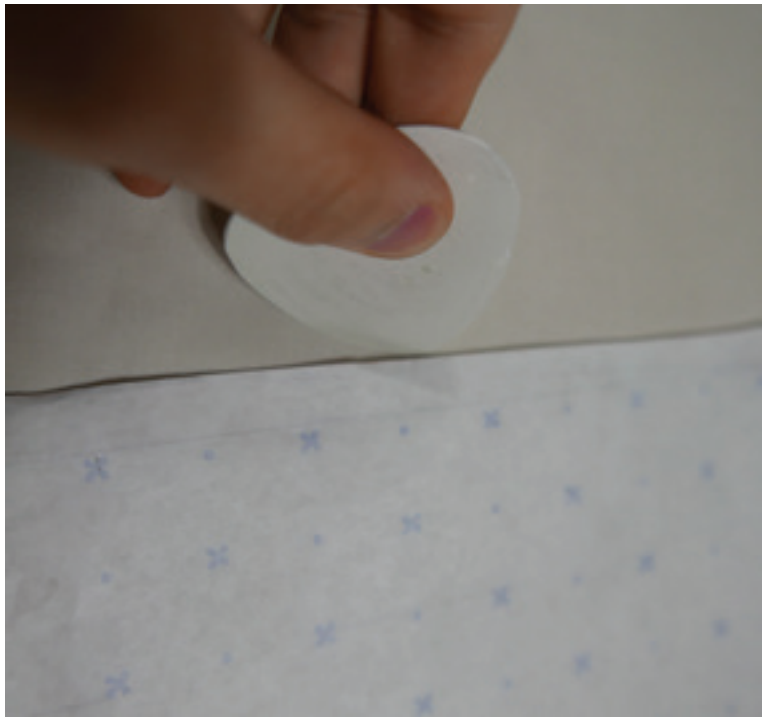

**Trace**



**Cut**

**Iron With  
Fusible**

### Step 4: Sewing Machine



**Sew**



**Cut**

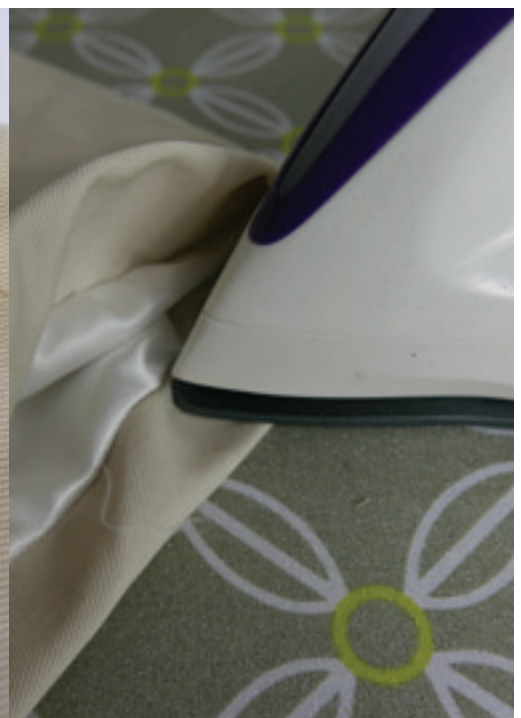

**Iron**

## Step 5: First Fit



Check form



Check Lining

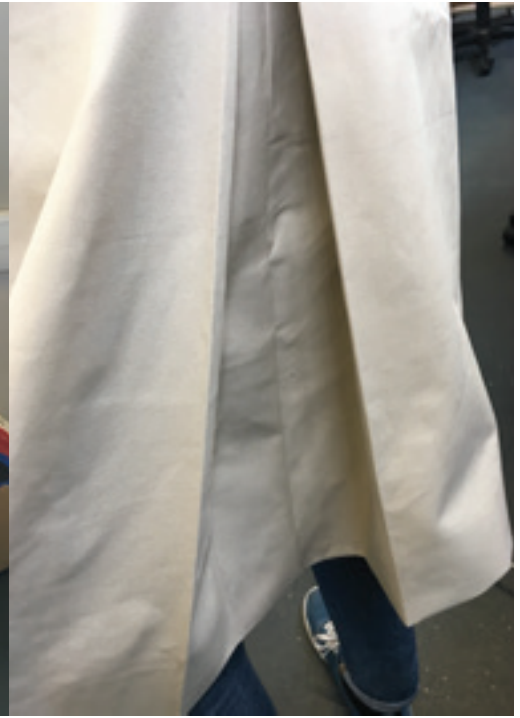

Check Godet

## Step 6: Done



Studio Picture



Out Door Picture

# Meaning Making

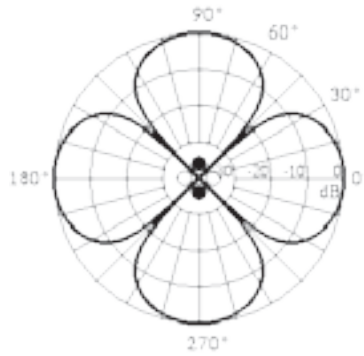

Fig. 4

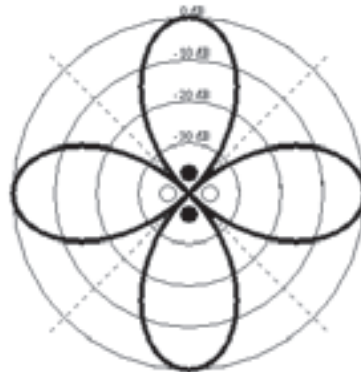
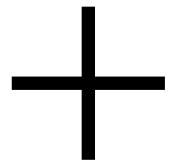
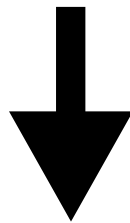
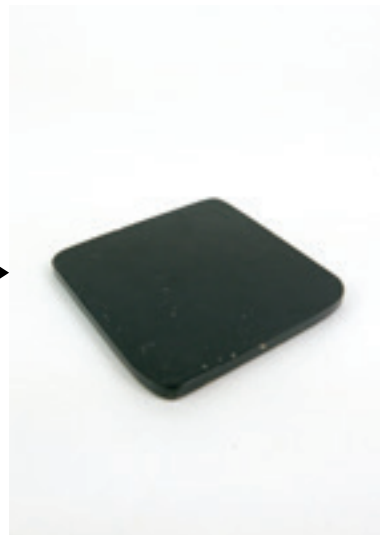
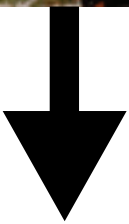
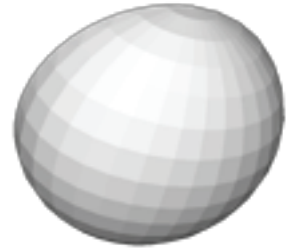

Fig. 5

Fig. 6



## Other Buttons Design



**Drafted in Rhino  
and exported to  
.stl file for CNC  
or 3D print**



# Blood Chit

## English

I AM A MEMBER OF THE BRITISH FORCES. PLEASE ASSIST ME AND HELP ME TO RETURN TO MY FRIENDS. THE BRITISH GOVERNMENT WILL REWARD YOU.

## Chinese

我是英国部队的成员。请帮助我并协助我回到我的朋友。英国政府将会奖励你。

## Pronunciation

Wo shi ying guo bu dui de cheng yuan.  
Qing bang zhu wo bing xie zhu wo hui dao wo de peng you. Ying guo zheng fu jiang hui jiang li ni.

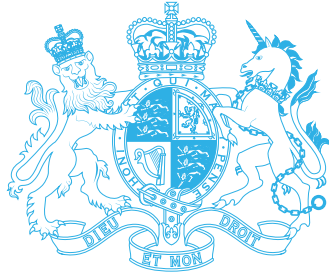

BE VERY COURTEOUS AND POLITE  
AT ALL TIMES

READ THE PRONUNCIATION LIKE ENGLISH

ARABIC READ FROM  
RIGHT TO LEFT

## Russian

Я из Британских военных сил. Пожалуйста проявите содействие и помогите мне вернуться к союзникам. Британское правительство вас щедро вознаградит.

## Pronunciation

Ya iz Britanskikh voyennykh sil.  
Pozhaluysta proyavite sodeystviye i pomogite mne vernut'sya k soyuznikam. Britanskoye pravitel'stvo vas shchedro voznaogradit.

## Arabic

انا عسكري انجليزي، من فضلك  
ساعدني لأرجع إلى أصدقائي فإن الحكومة  
البريطانية ستدفع لك الكثير من النقود

## Pronunciation

'inna eskry anjlyzy, min fadlik  
saeadni li'arjae 'ilay 'asdaqiyiy fa'inn  
al hukuma  
albritaniat satadfae lak alkthyr min  
alnuqud



Ministry  
of Defence



**Drafted influenced by the actual Blood Chit  
used by the RAF Pilots.  
Modernised the font, Coat of Armed and  
sharper colours are chosen.**



# Keep It Simple

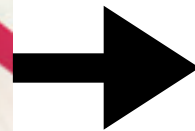
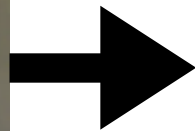
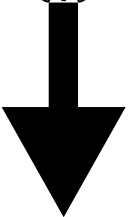
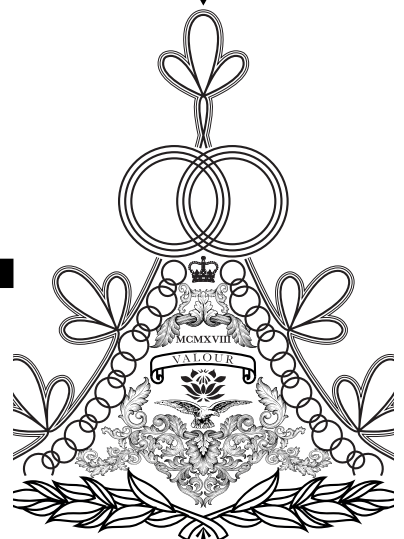
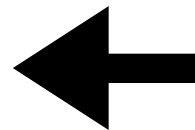
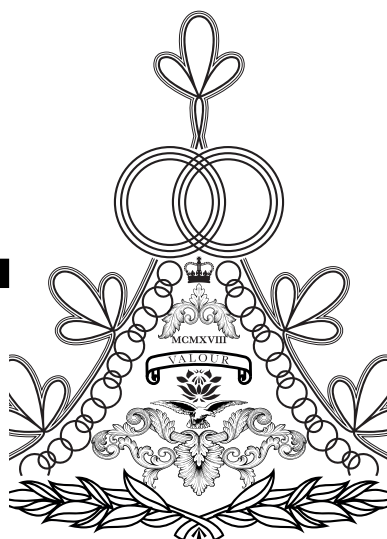
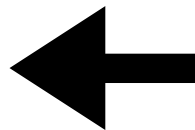
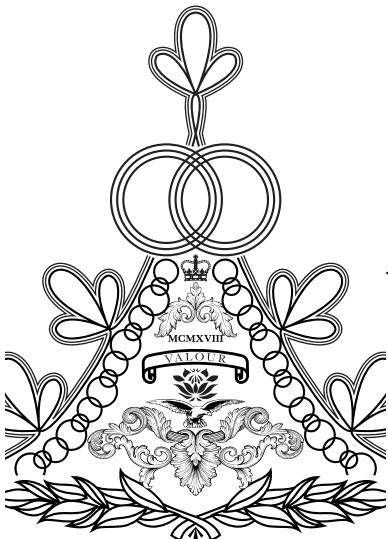
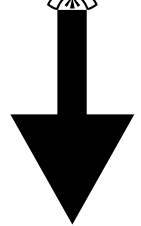
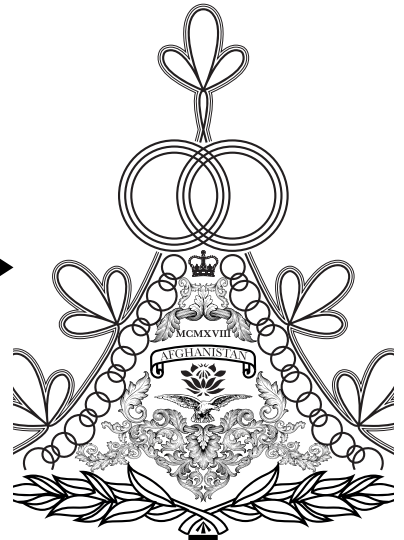
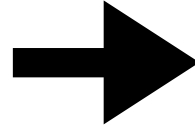
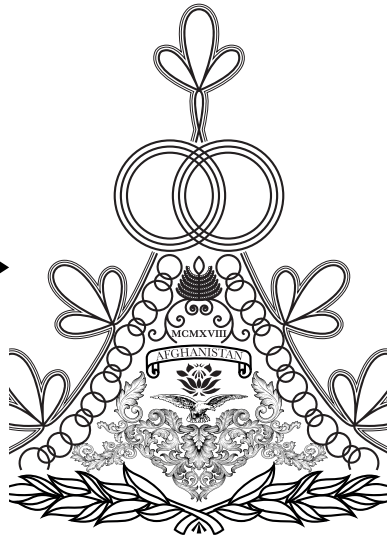
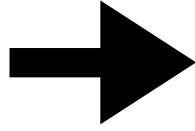
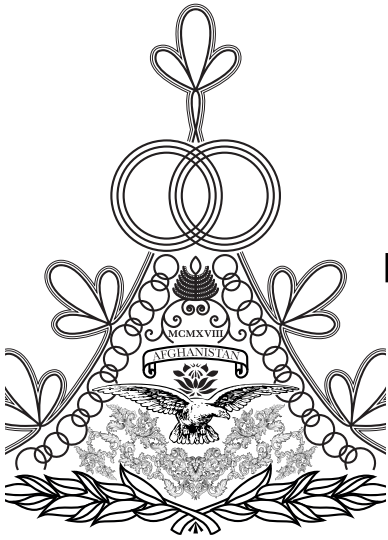

# Work In Progress



Fig.7

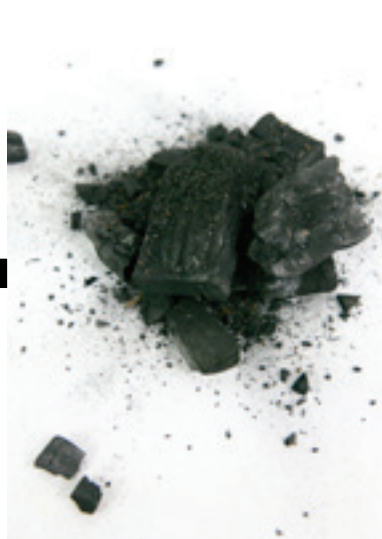



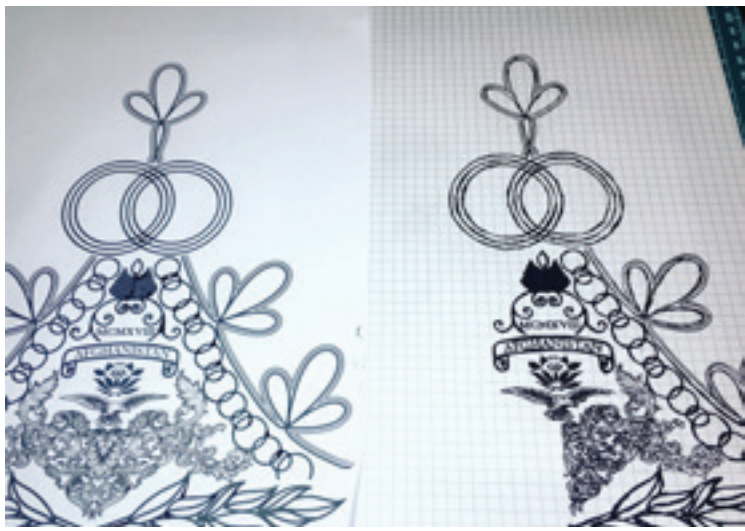



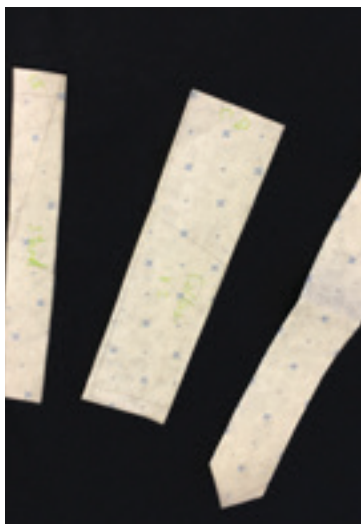



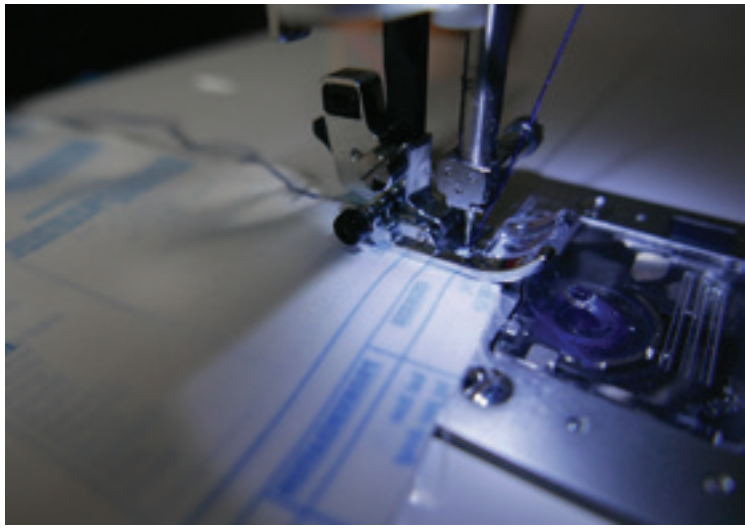







# Final Outcome

























# Other Products

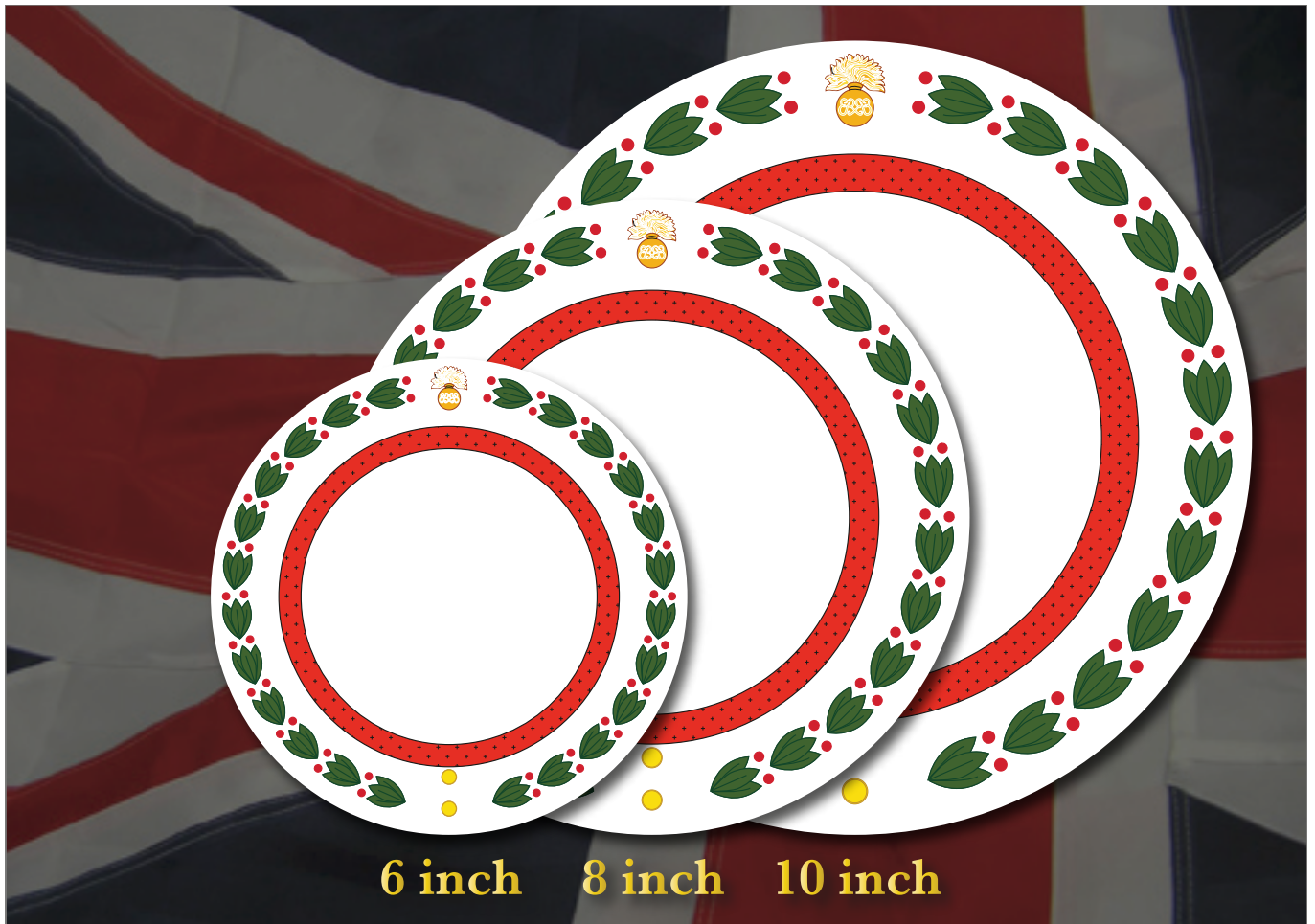

Tableware for Foot Guards  
Mess Dinner Plates



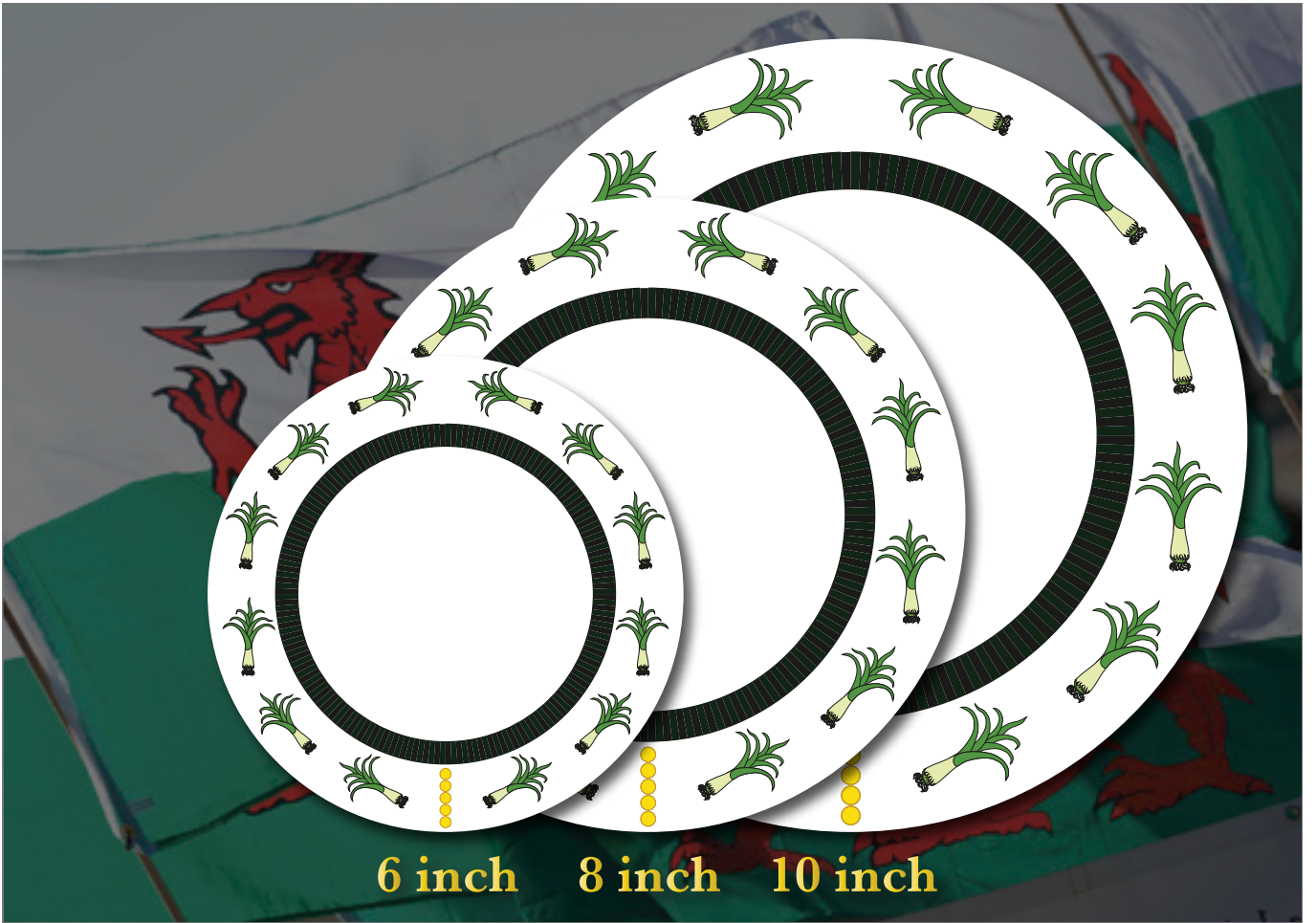

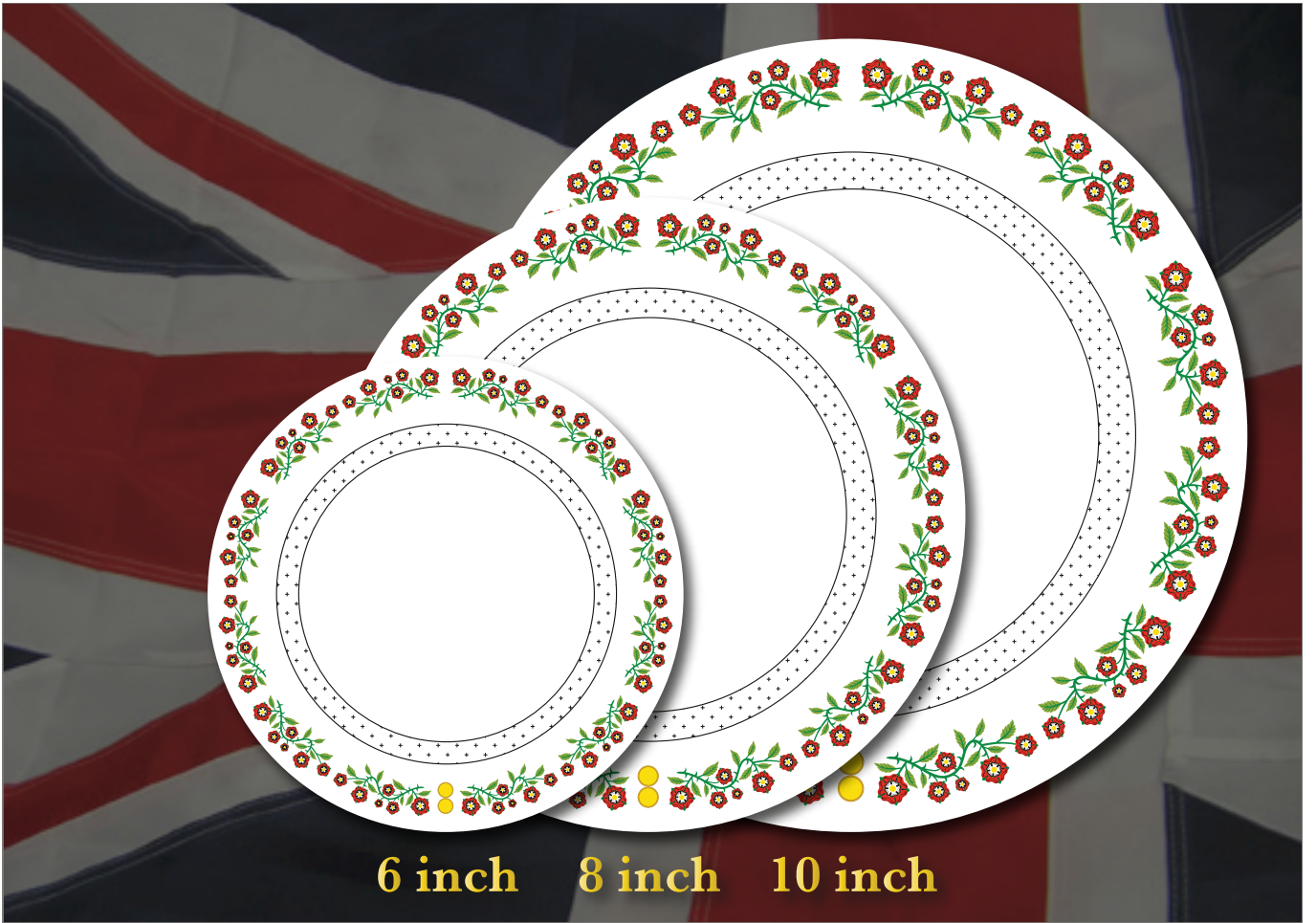

6 inch 8 inch 10 inch



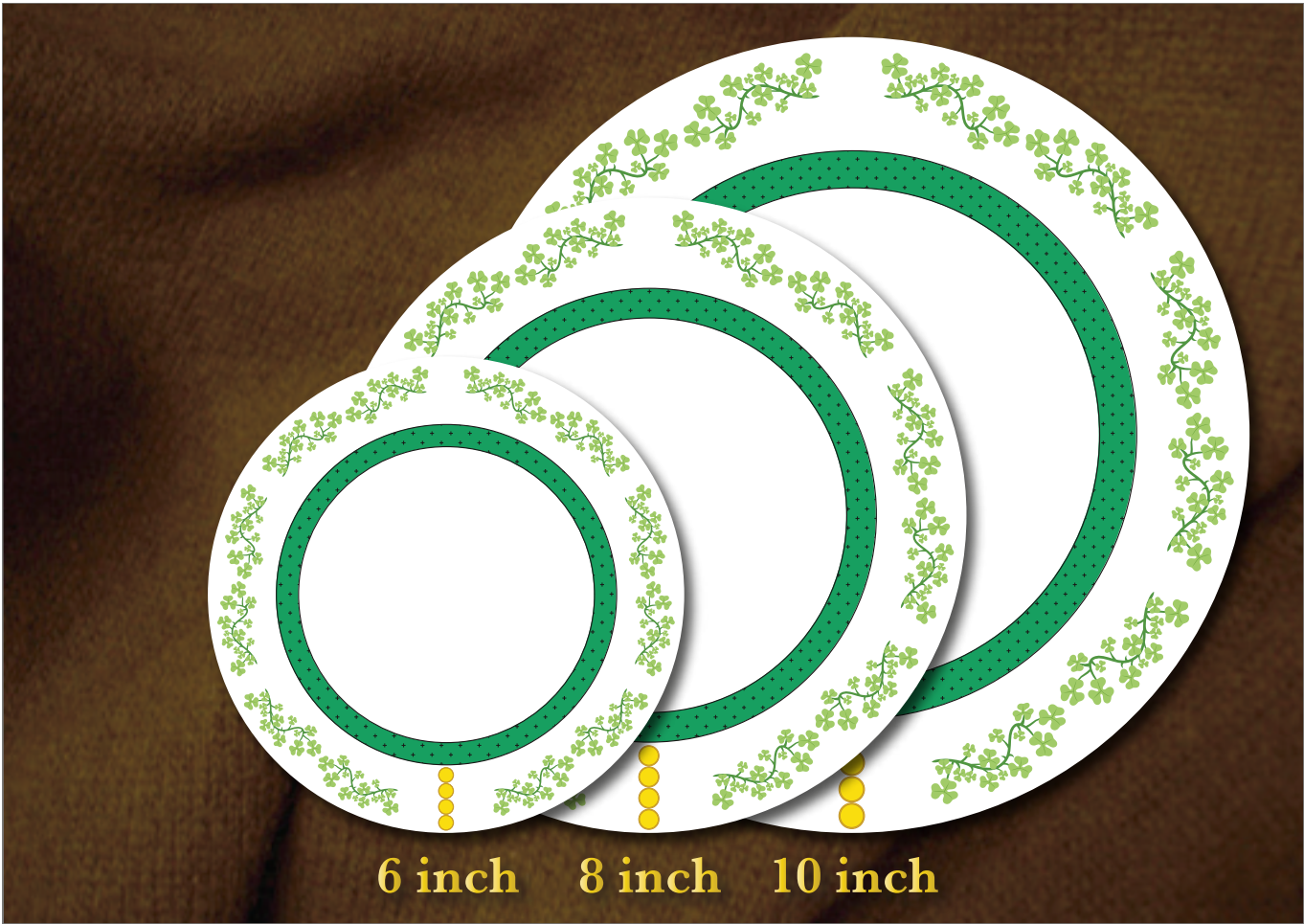

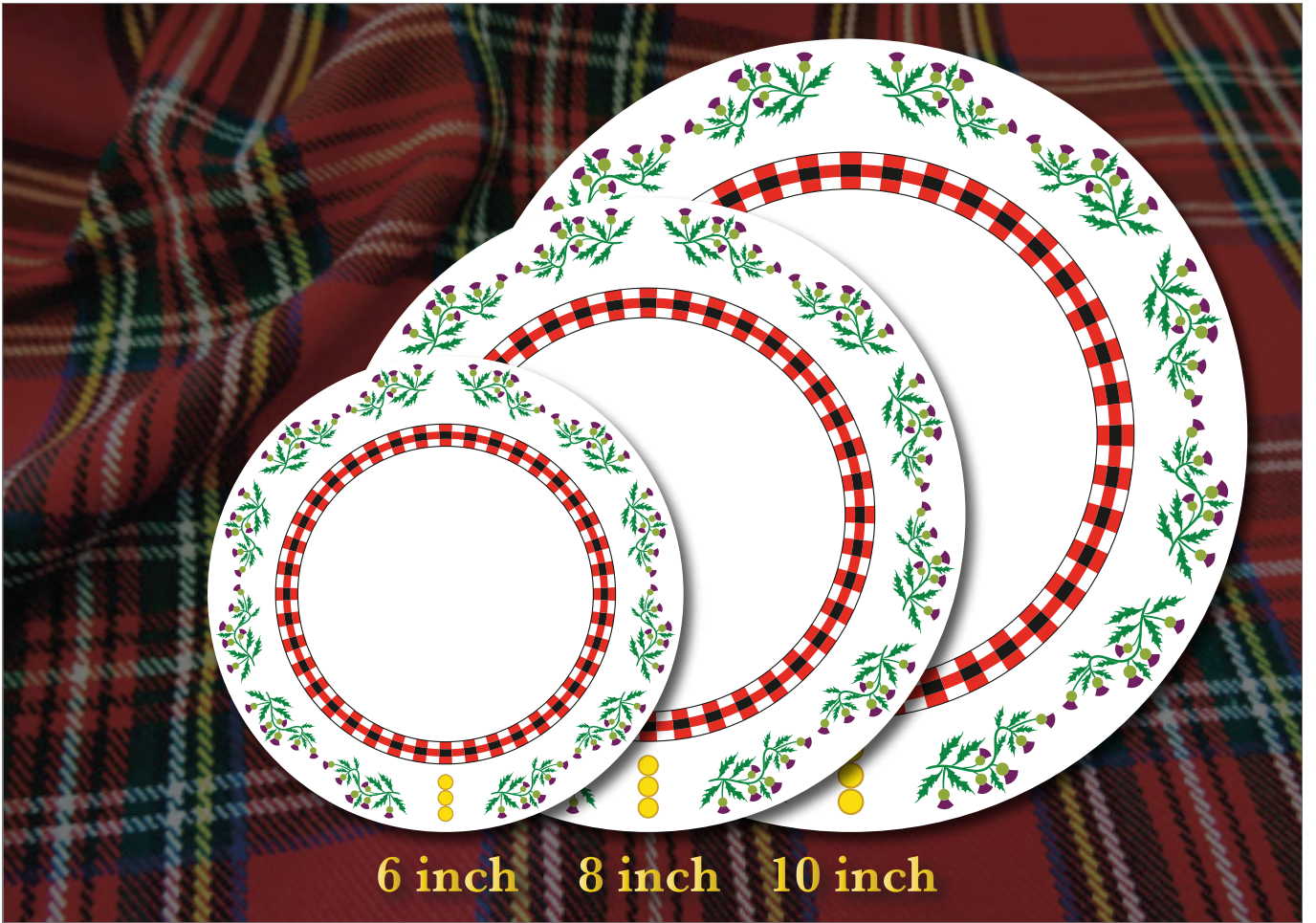

6 inch 8 inch 10 inch



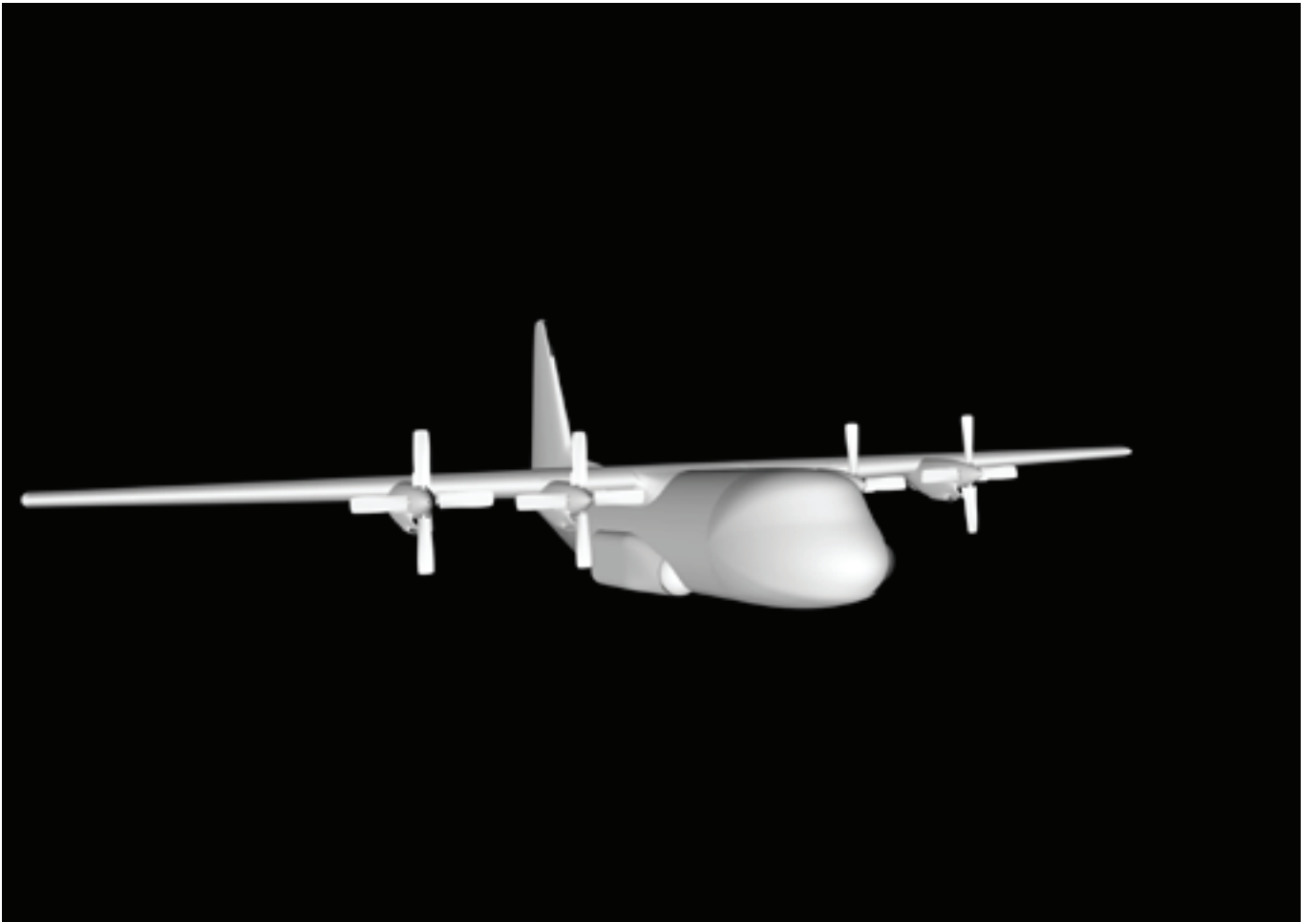

**Prototypes of  
Die-Cast Solid Silver  
Figurines  
Drafted inRhino**

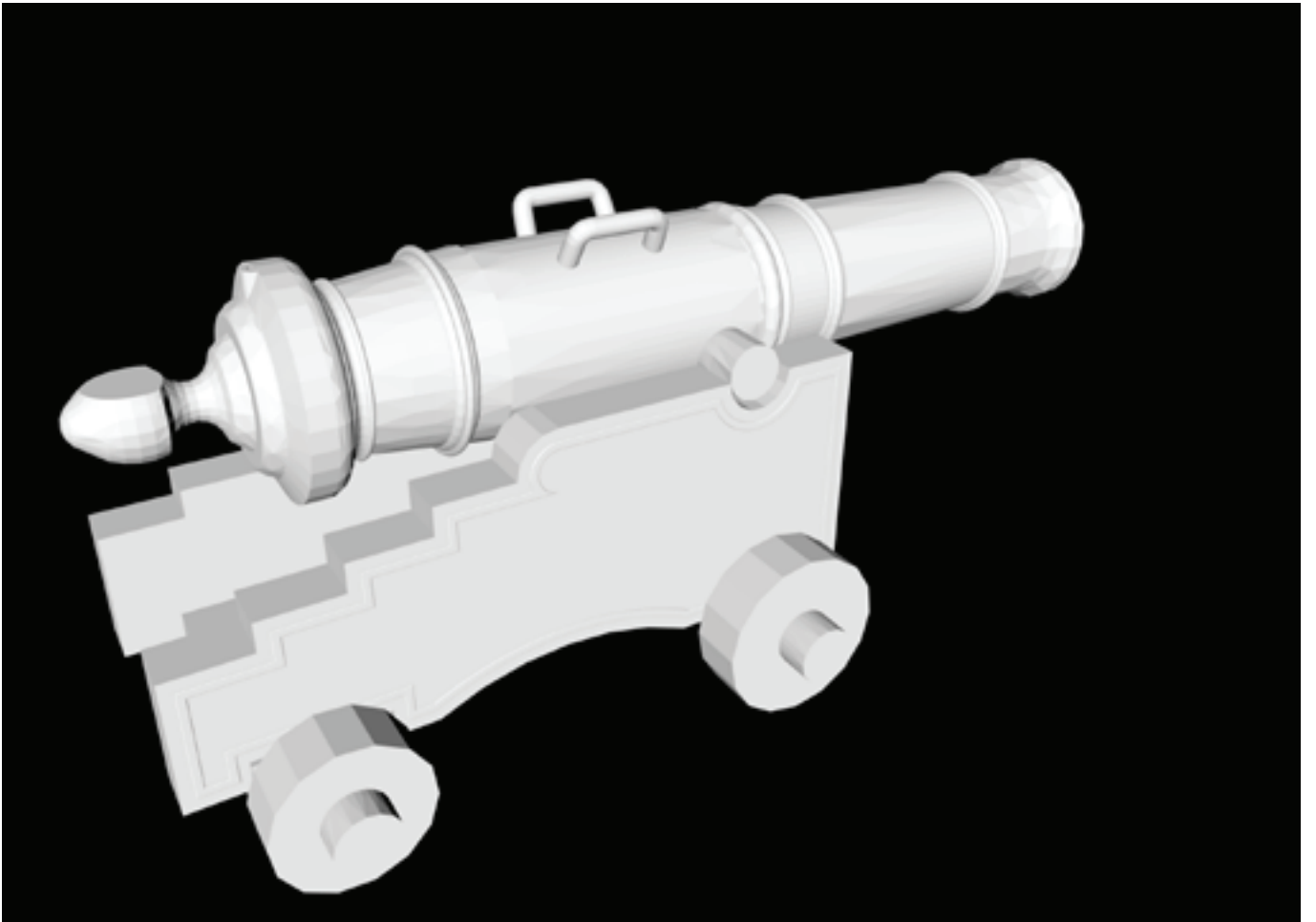



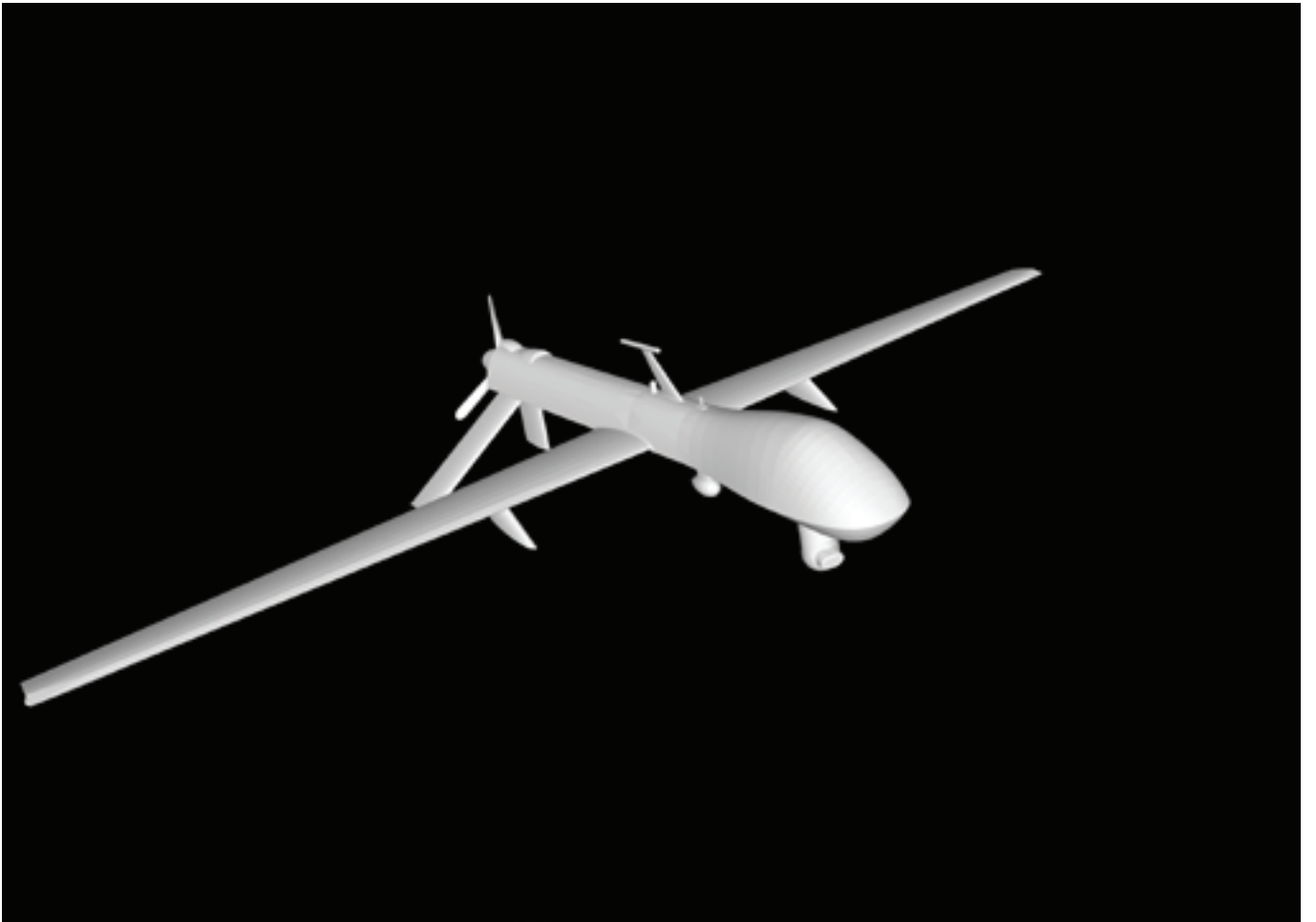



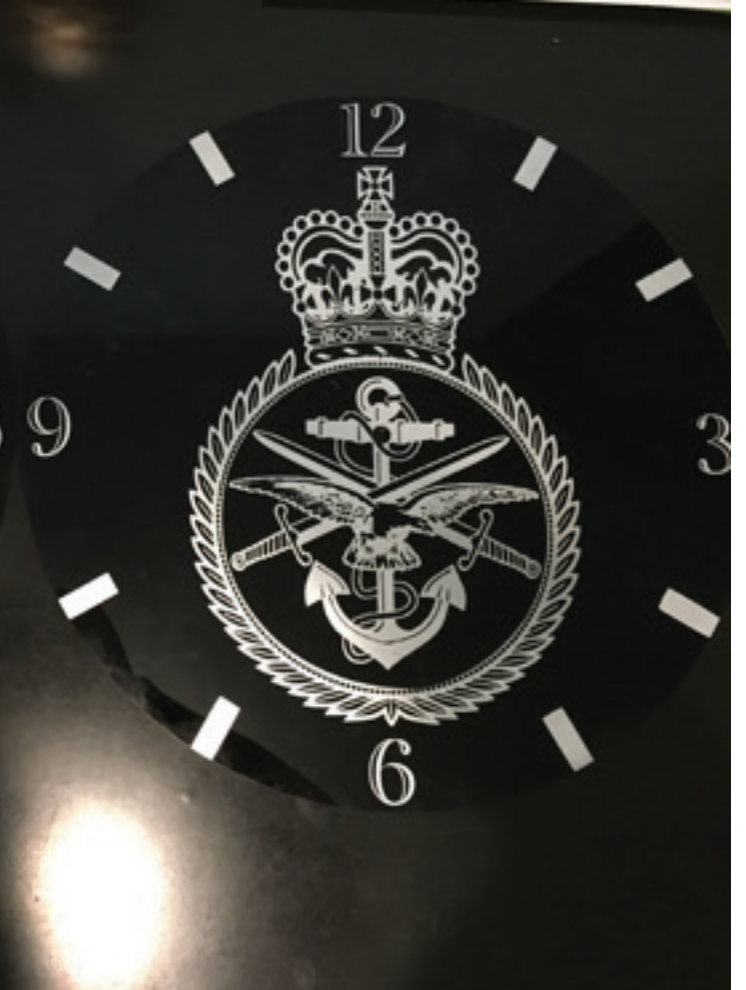
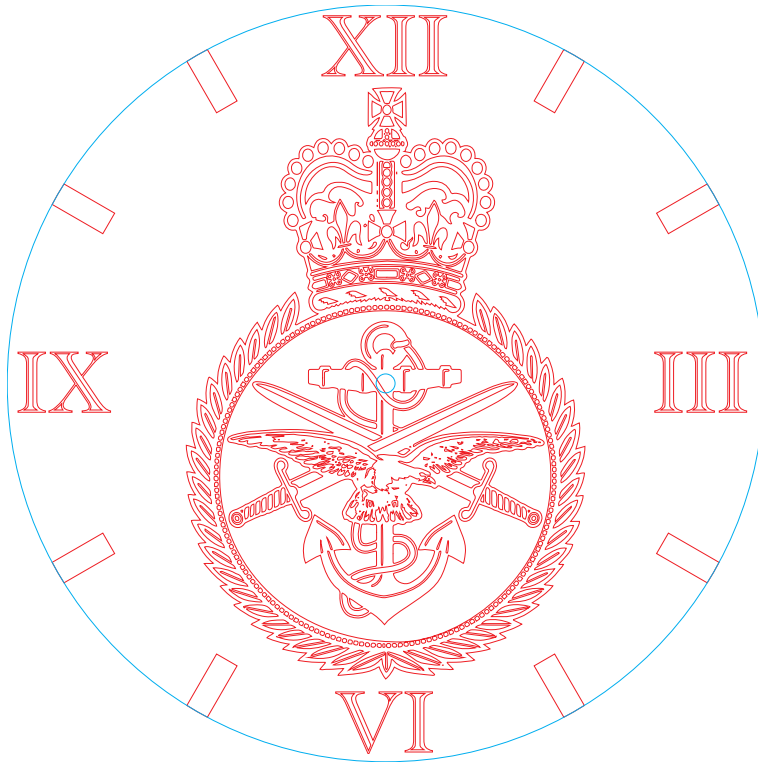







# Building a Brand

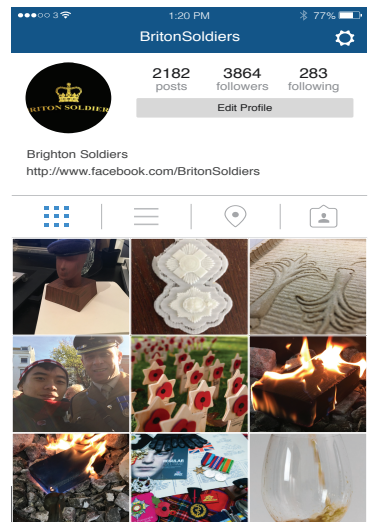
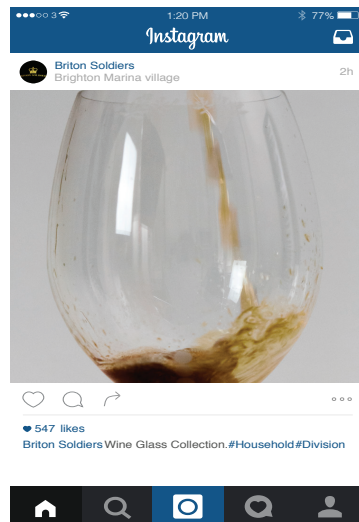
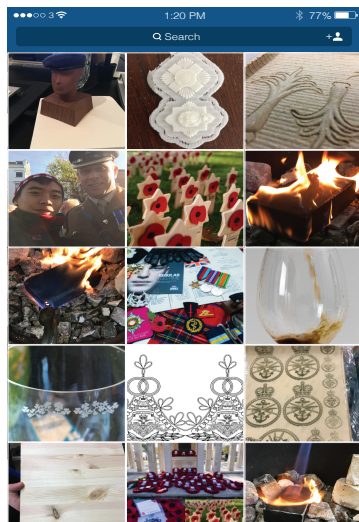
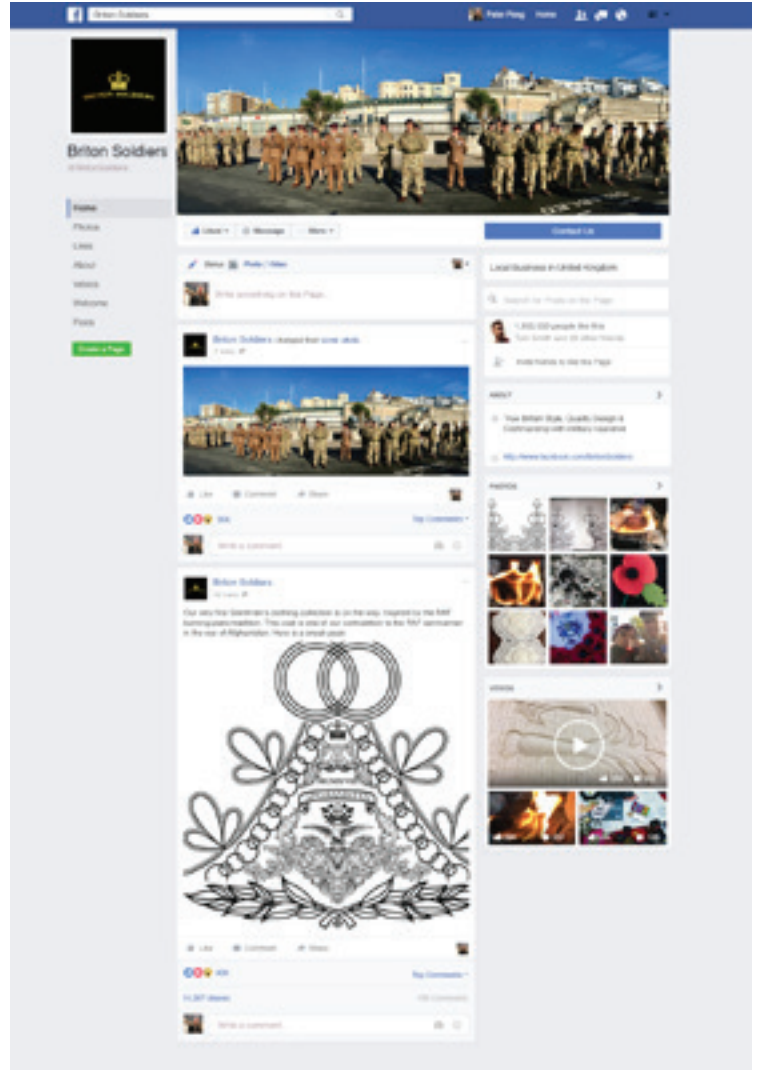

# Appendix

- ⊗ Fig.1 <http://imgur.com/E2yZpJw>
- ⊗ Fig.2 <https://uk.burberry.com/the-kensington-mid-length-heritage-trench-coat-p39833381>
- ⊗ Fig.3 <http://theminaturespage.com/boards/msg.mv?id=316598>
- ⊗ Fig.4 <http://www.acs.psu.edu/drussell/Demos/radiation/radiation.html>
- ⊗ Fig.5 <http://www.maxwell.af.mil/News/Display/Article/704219/us-royal-air-force-officers-commemorate-battle-of-britain-with-piano-burn/>
- ⊗ Fig.6 <http://www.acs.psu.edu/drussell/Demos/radiation/radiation.html>
- ⊗ Fig.7 <http://www.piano-warehouse.co.uk/pianos/weber-w175-bp-grand-piano/>

Youtube Video of the photoshoot day.  
[https://youtu.be/qyBwO\\_qTWdU](https://youtu.be/qyBwO_qTWdU)

Directing, Editing & Filming: Peter  
Modelling: Liam & Tom  
Photographs: Trevor & Vanessa





READ THE PRONUNCIATION LABEL  
AT ALL TIMES  
BE VERY COURTEOUS AND POLITE

